

JUEGO DE PIEZAS PARA CABLEADO,
CONEXION POR TORNILLO,
ELECTRICO Y MECANICO,
INCL. ENCLAVAMIENTO MECANICO,
PARA ARRANCADOR INVERSOR, TAM. S0

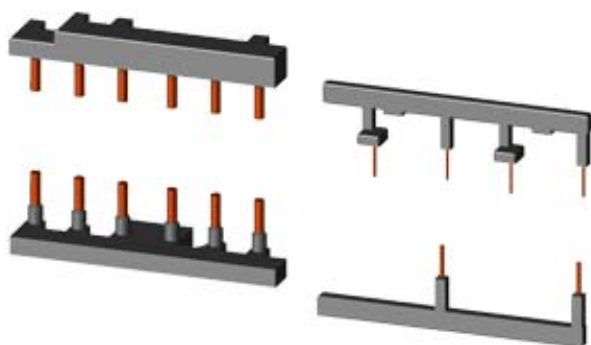













Datos técnicos generales:

Nombre comercial del producto	SIRIUS
Designación del producto	kit de cableado para contactores inversores S0, conexión por tornillo
Tamaño del contactor	S0
Versión del producto	tensión de accionamiento del contactor: AC y DC

Instalación/fijación/dimensiones:

Modo de sujeción	fijación por tornillo
-------------------------	-----------------------

Certificados/Homologaciones:

General Product Approval			Declaration of Conformity	Test Certificates	
 CSA		 UR	 EG-Konf.	Special Test Certificate	
Shipping Approval					
 ABS	 BUREAU VERITAS	 DNV	 GL	 LRS	 PRS
Shipping Approval		other			
 RINA	 RMRS	other	Environmental Confirmations		

Otras informaciones:

Information- and Downloadcenter (Catálogos, Folletos,...)

<http://www.siemens.com/industrial-controls/catalogs>

Industry Mall (sistema de pedido online)

<http://www.siemens.com/industrial-controls/mall>

CAX-Online-Generator

<http://www.siemens.com/cax>

Service&Support (Manuales, certificados, características, FAQ,...)

<http://support.automation.siemens.com/WW/view/es/3RA2923-2AA1/all>

Base de datos de imágenes (fotos de producto, dibujos acotados 2D, modelos 3D, esquemas de conexiones, ...)

http://www.automation.siemens.com/bilddb/cax_en.aspx?mlfb=3RA2923-2AA1

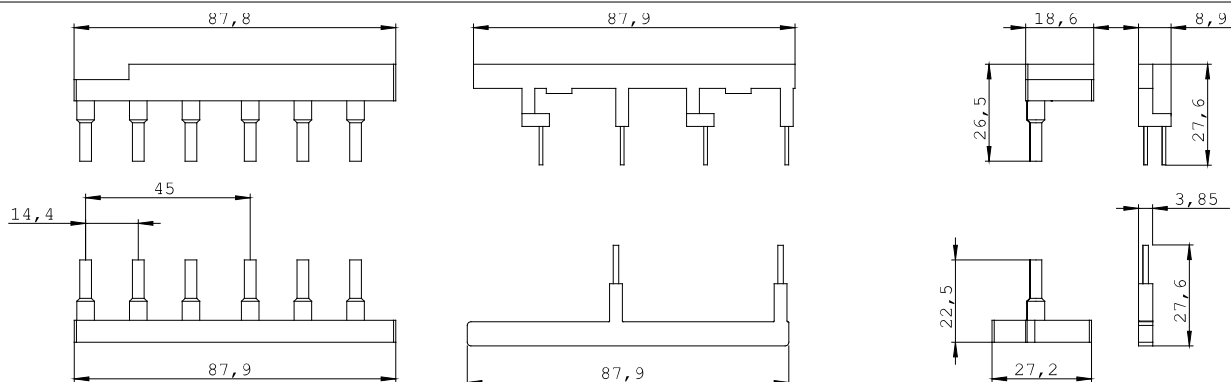

último cambio:

14-jun-2014