









CIERRE MECANICO P. CONTACTORES TAM. S6/S10/S12
3RT10/3RT12/3RT14

Certificados/ Homologaciones:

General Product Approval		Declaration of Conformity	
 CSA		 UL	 EG-Konf.
Shipping Approval		other	
 BUREAU VERITAS	 GL	 RINA	other Environmental Confirmations

Otras informaciones:

Information- and Downloadcenter (Catálogos, Folletos,...)

<http://www.siemens.com/industrial-controls/catalogs>

Industry Mall (sistema de pedido online)

<http://www.siemens.com/industrial-controls/mall>

Generador CAx online

<http://www.siemens.com/cax>

Service&Support (Manuales, certificados, características, FAQ,...)

<http://support.automation.siemens.com/WW/view/es/3RA1954-2A/all>

Base de datos de imágenes (fotos de producto, dibujos acotados 2D, modelos 3D, esquemas de conexiones, ...)

http://www.automation.siemens.com/bilddb/cax_en.aspx?mlfb=3RA1954-2A

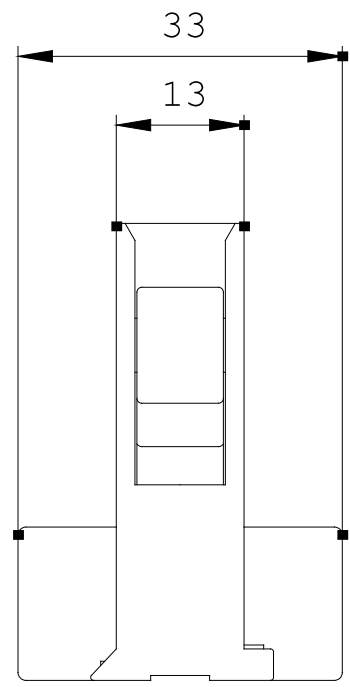
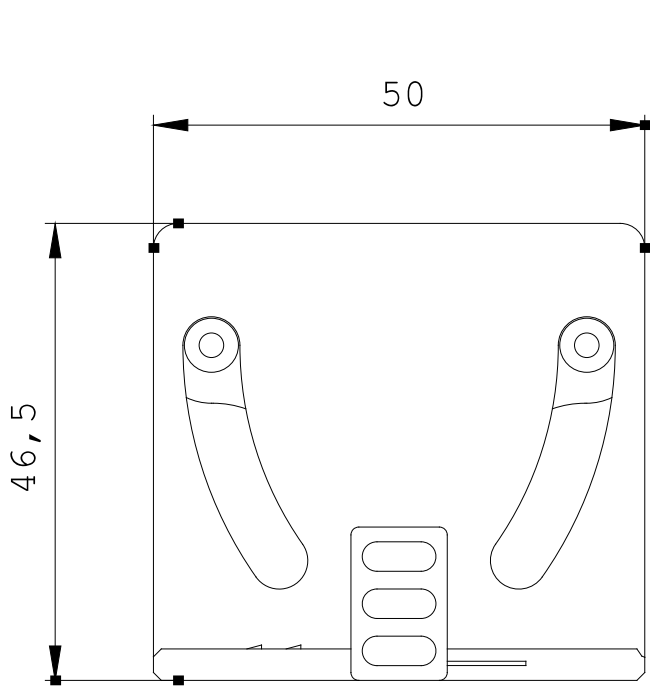

último cambio: